

MOUNTING TORQUE FOR BC	not to exceed 100 in/lbs
MATED PRESSURE RATING (psi)	10,000
DUMMY PLUG FOR IE2M-5/8, IE2M-BC	IE2F-5/8-DO*
DUMMY PLUG FOR IE2F-BC, IE2F-5/8	IE2M-5/8-DO*
* Shorted dummies (DS) available upon request.	

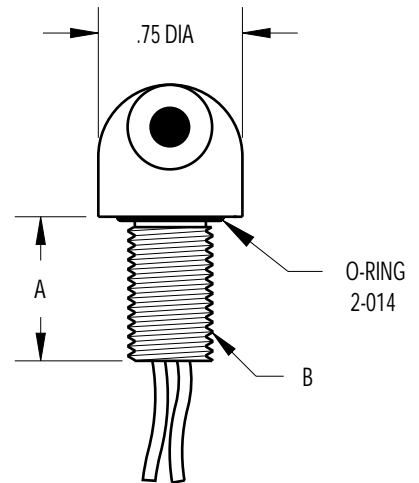

MOUNTING TORQUE FOR BC	not to exceed 100 in/lbs
MATED PRESSURE RATING (psi)	10,000
DUMMY PLUG FOR IERD2F-BC	IE2M-7/16-DO*
DUMMY PLUG FOR IERD2M-BC	IE2F-5/8 DO*
* Shorted dummies (DS) available upon request. ** See chart for thread specifications. *** Specify M/F	

PART NUMBER	B	A
IERD2***-BC-1	3/8-24 UNF-2A	.50
IERD2***-BC-2	3/8-24 UNF-2A	.75
IERD2***-BC-3	3/8-24 UNF-2A	1.00
IERD2***-BC-4	7/16-20 UNF-2A	.50
IERD2***-BC-5	7/16-20 UNF-2A	.75
IERD2***-BC-6	7/16-20 UNF-2A	1.00

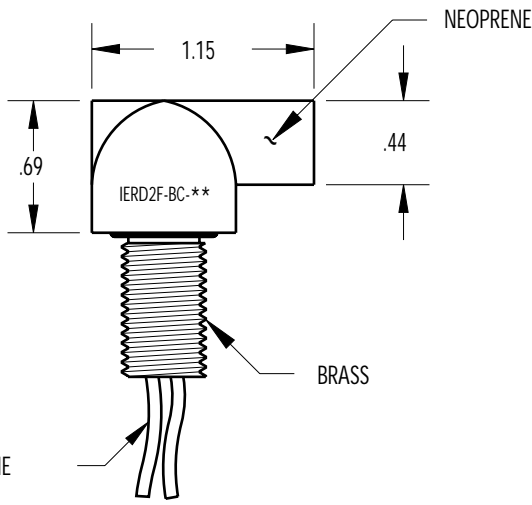
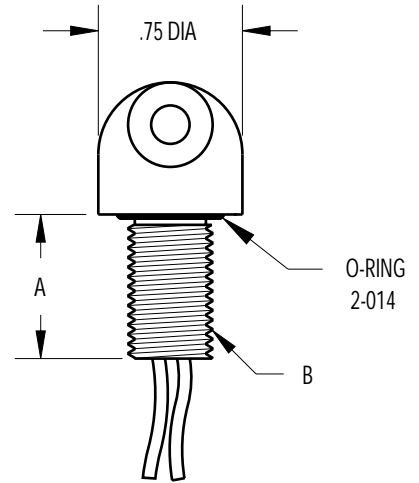
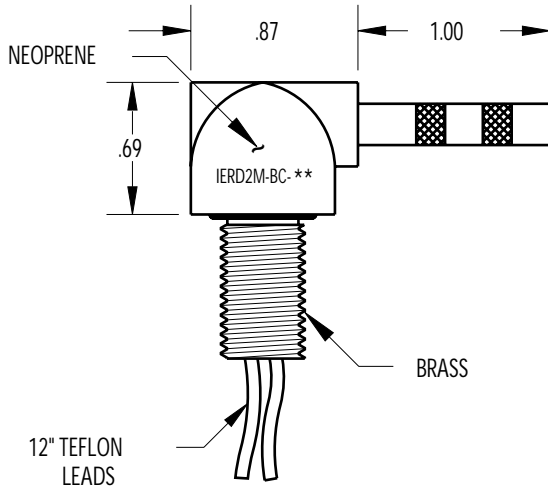
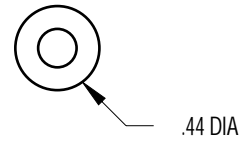
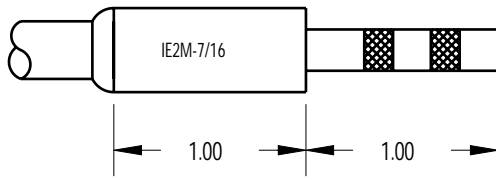
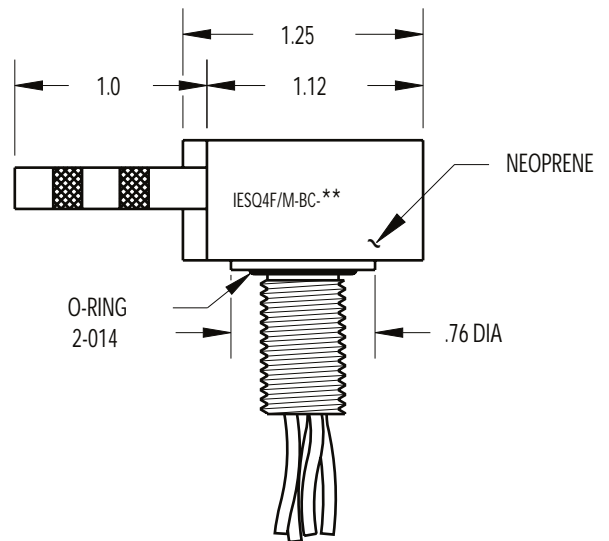
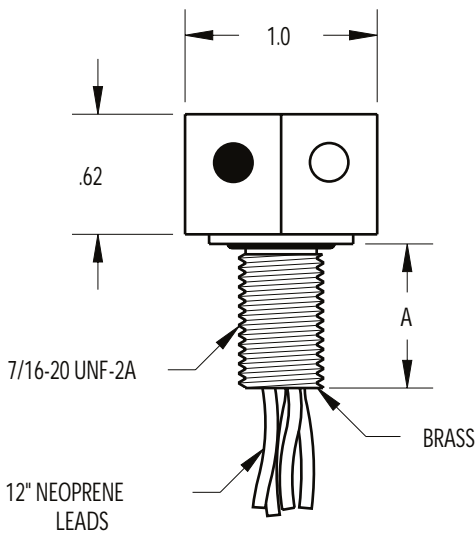
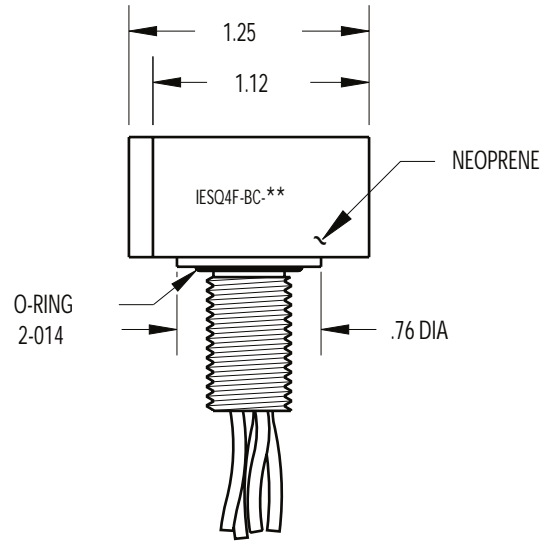
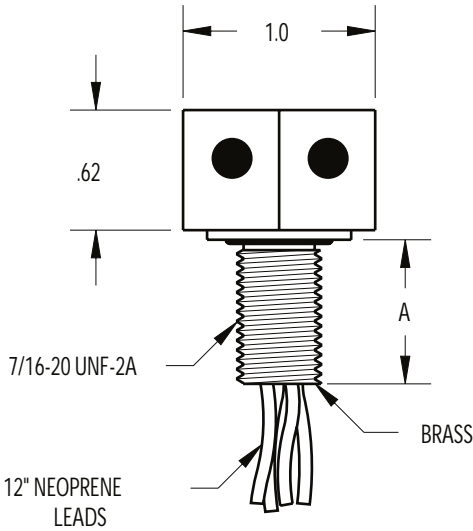
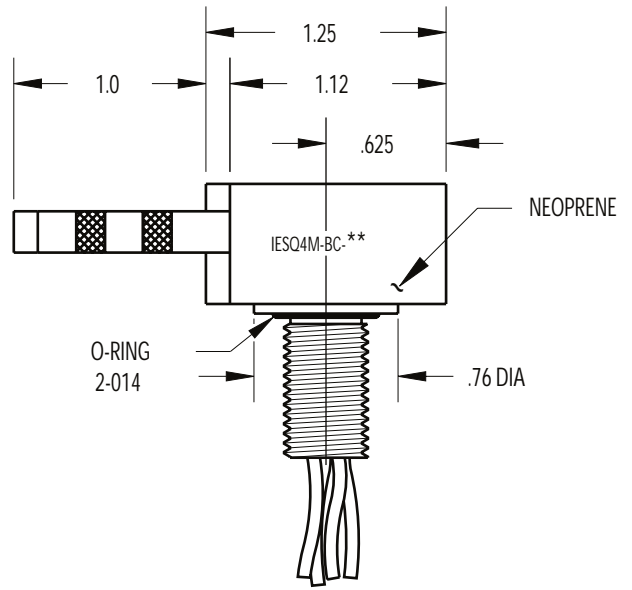
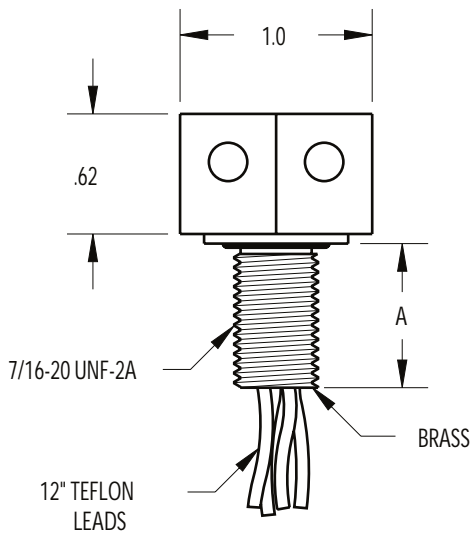

SCALE 1:1

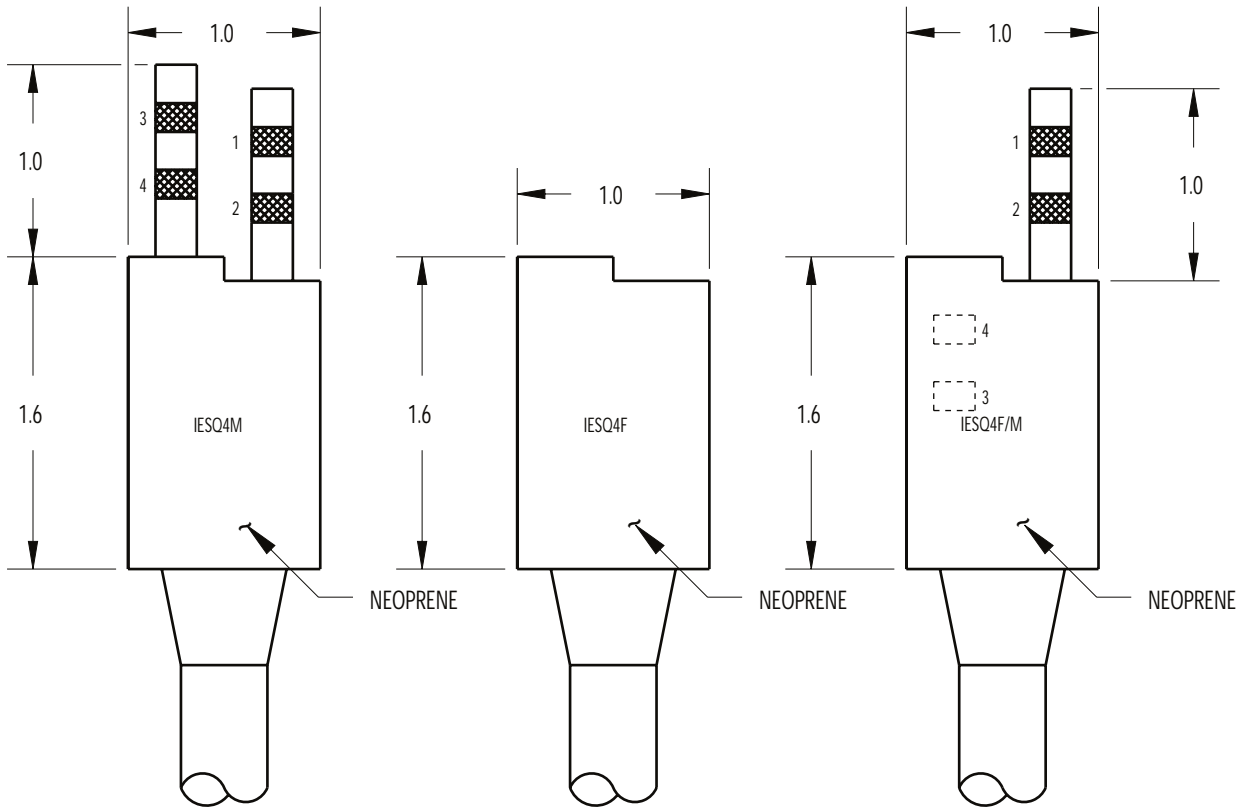

MOUNTING TORQUE FOR BC	not to exceed 100 in/lbs
MATED PRESSURE RATING (psi)	5,000
DUMMY PLUG FOR IESQ4M-BC, IESQ4M	IESQ4F-DO *
DUMMY PLUG FOR IESQ4F-BC, IE2F	IESQ4M-DO *
DUMMY PLUG FOR IESQ4MF-BC, IESQ4F/M	IESQ4F/M-DO *
* Shorted dummies available upon request. ** See chart for thread specifications. *** Specify M, F, F/M	

BULKHEAD	
PART NUMBER	A
IESQ4***-BC-1	.50
IESQ4***-BC-2	.75
IESQ4***-BC-3	1.00

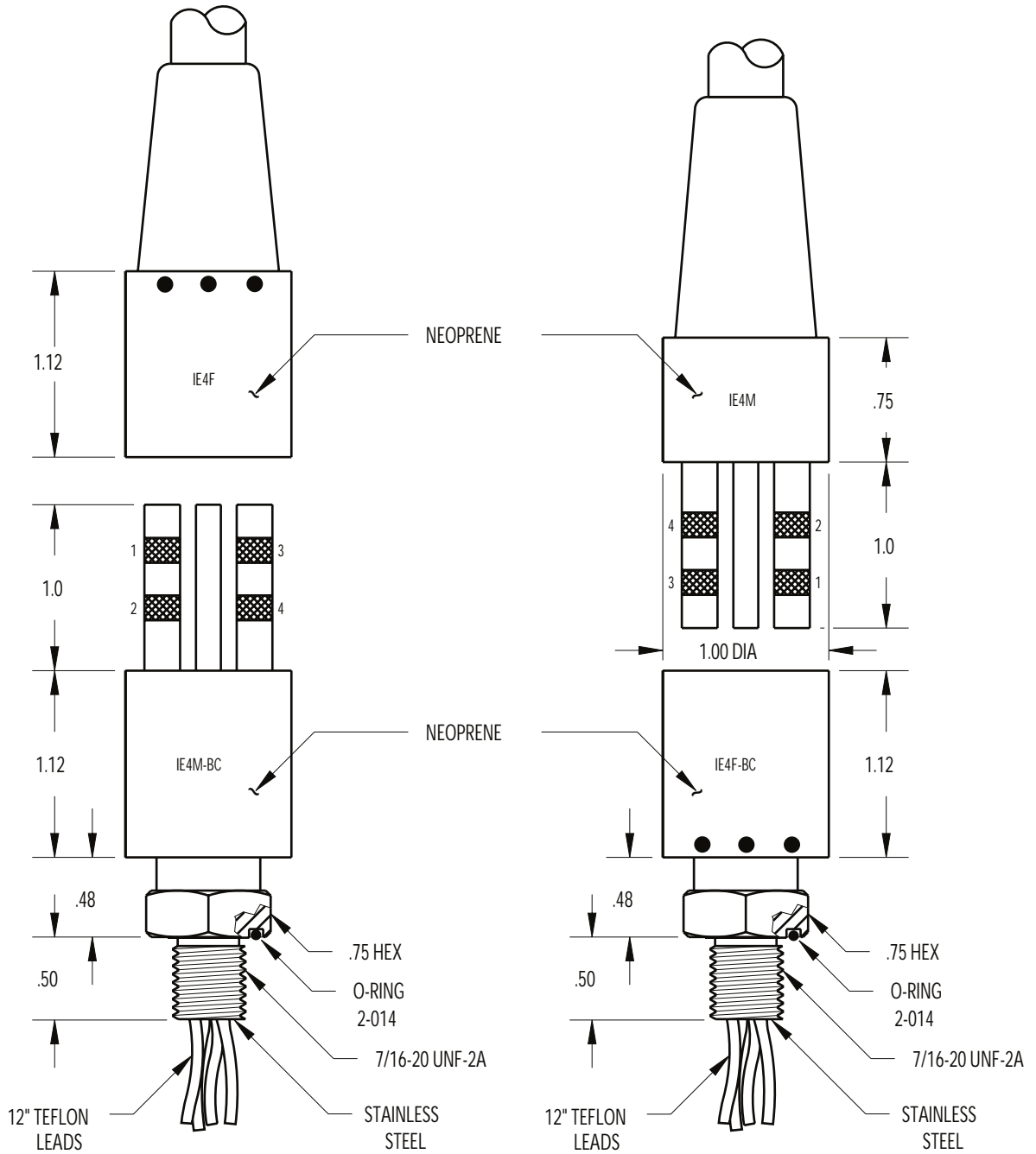

MOUNTING TORQUE FOR BC	not to exceed 100 in/lbs
MATED PRESSURE RATING (psi)	10,000
DUMMY PLUG FOR IE4M-BC, IE4M	IE4F-DO *
DUMMY PLUG FOR IE4F-BC, IE4F	IE4M-DO *
* Shorted dummies (DS) available upon request.	

CONTACT CONFIGURATION
(IE4M FACE VIEW)

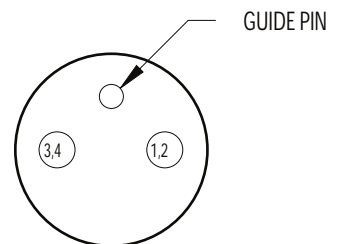

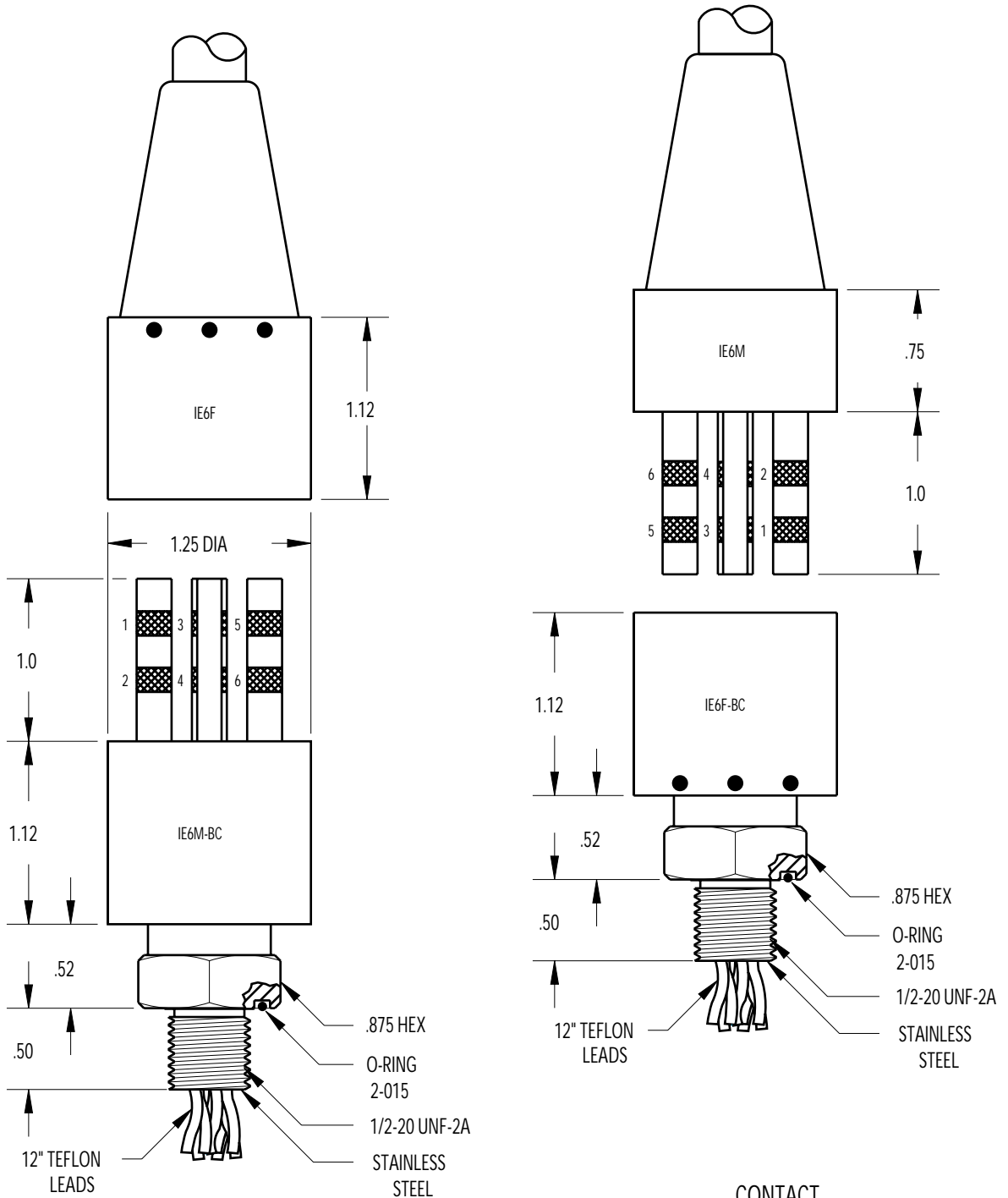

MOUNTING TORQUE FOR BC	not to exceed 100 in/lbs
MATED PRESSURE RATING (psi)	10,000
DUMMY PLUG FOR IE6/8M-BC, IE6/8M	IE6/8F-DO *
DUMMY PLUG FOR IE6/8F-BC, IE6/8F	IE6/8M-DO *
* Shorted dummies (DS) available upon request.	

CONTACT CONFIGURATIONS
(IE6/8M FACE VIEWS)

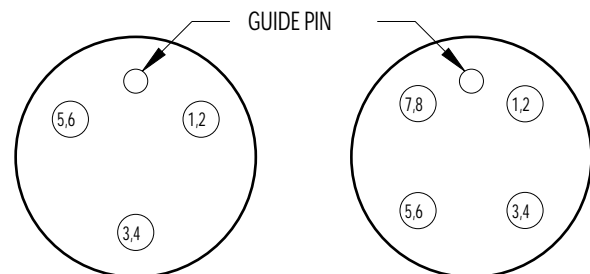

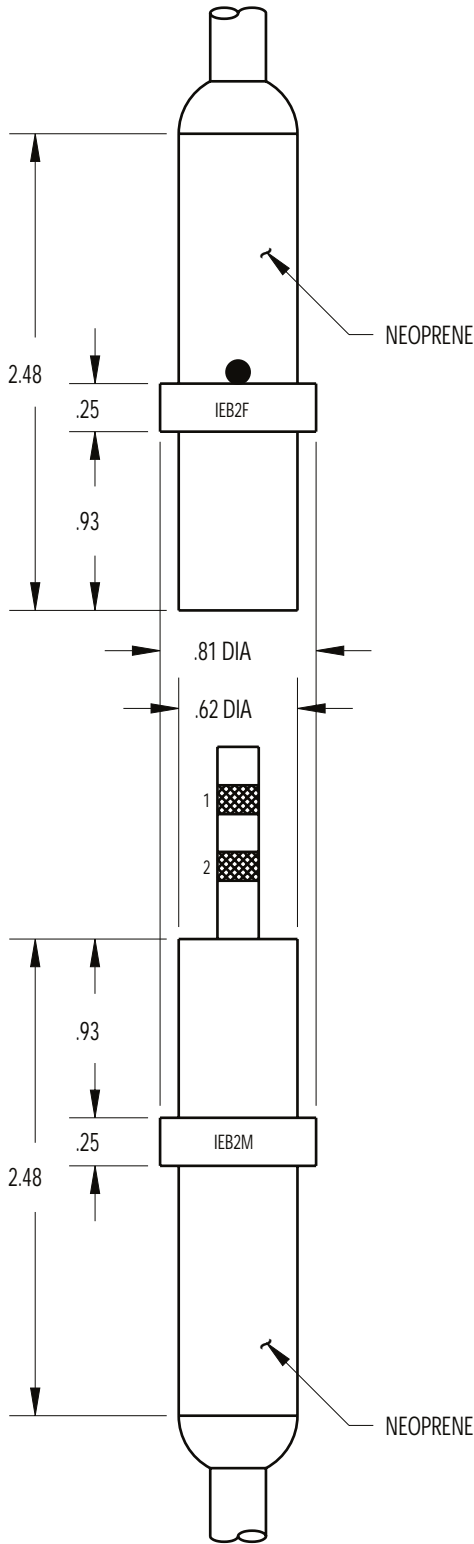

IEB2M FACE VIEW

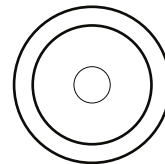

MATED PRESSURE RATING (psi)	10,000
DUMMY PLUG FOR IEB2M	IEB2F-DO *
DUMMY PLUG FOR IEB2F	IEB2M-DO *
* Shorted dummies (DS) available upon request.	

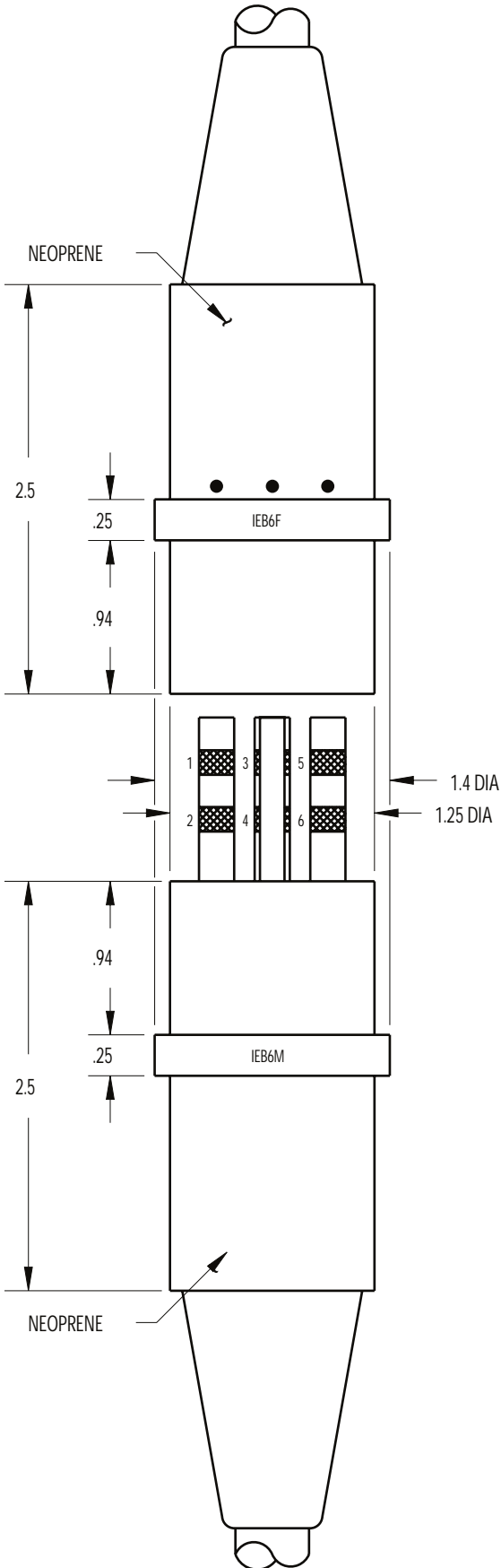

CONTACT CONFIGURATIONS
(IEB6/8M FACE VIEWS)

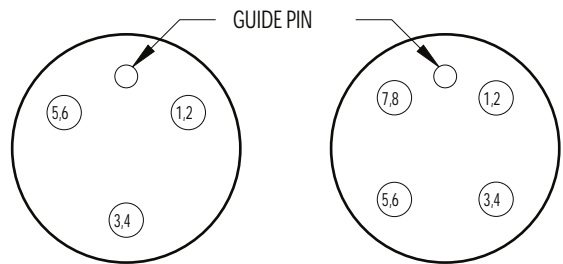

MATED PRESSURE RATING (psi)	20,000
DUMMY PLUG FOR IEB6/8M	IEB6/8F-DO *
DUMMY PLUG FOR IEB6/8F	IEB6/8M-DO *
* Shorted dummies (DS) available upon request.	

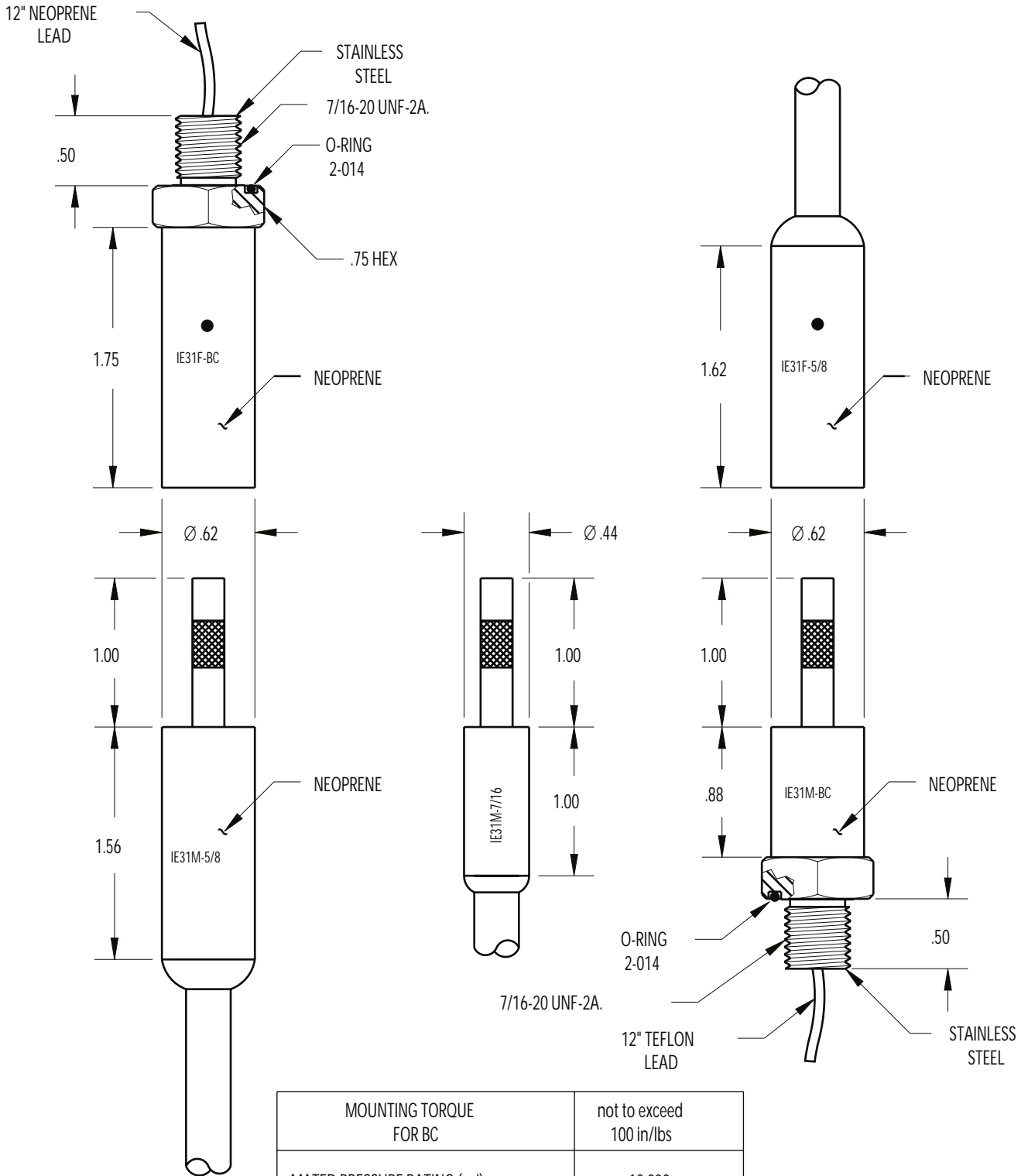

MOUNTING TORQUE FOR BC	not to exceed 100 in/lbs
MATED PRESSURE RATING (psi)	10,000
DUMMY PLUG FOR IE31M-5/8, IE31M-BC	IE31F-5/8-DO *
DUMMY PLUG FOR IE31F-BC, IE31F-5/8	IE31M-5/8-DO *
* Shorted dummies (DS) available upon request.	

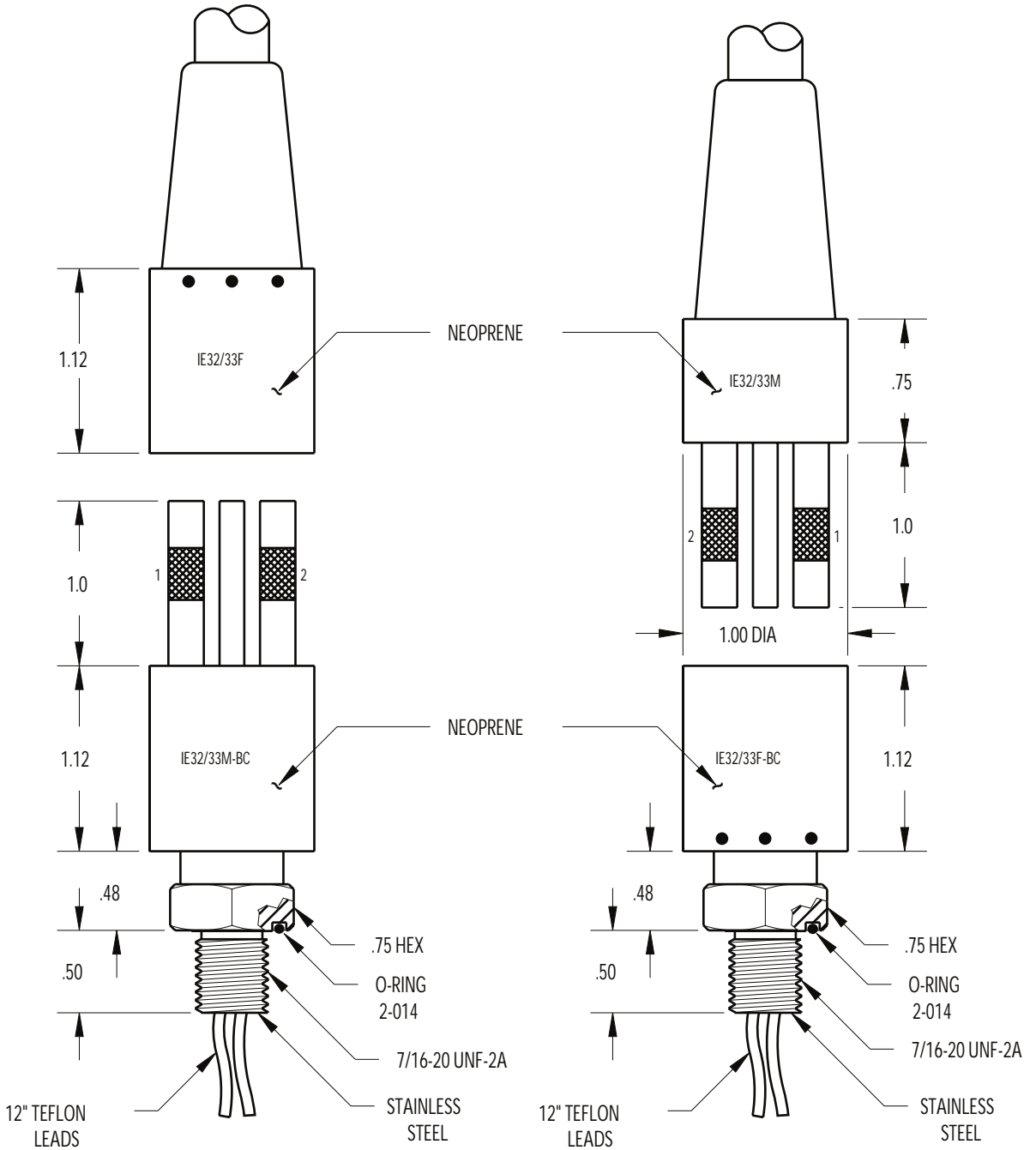

**CONTACT
CONFIGURATION**
(BC FACE VIEWS)

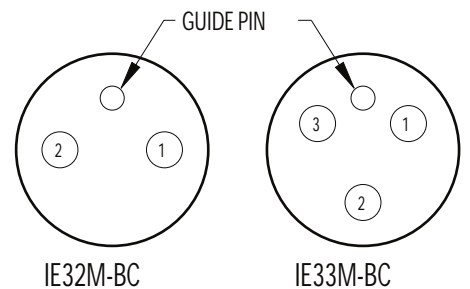

MOUNTING TORQUE FOR BC	not to exceed 100 in/lbs
MATED PRESSURE RATING (psi)	10,000
DUMMY PLUG FOR IE32/33M-BC, IE32/33M	IE32/33F-DO *
DUMMY PLUG FOR IE32/33F-BC, IE32/33F	IE32/33M-DO *
* Shorted dummies (DS) available upon request.	

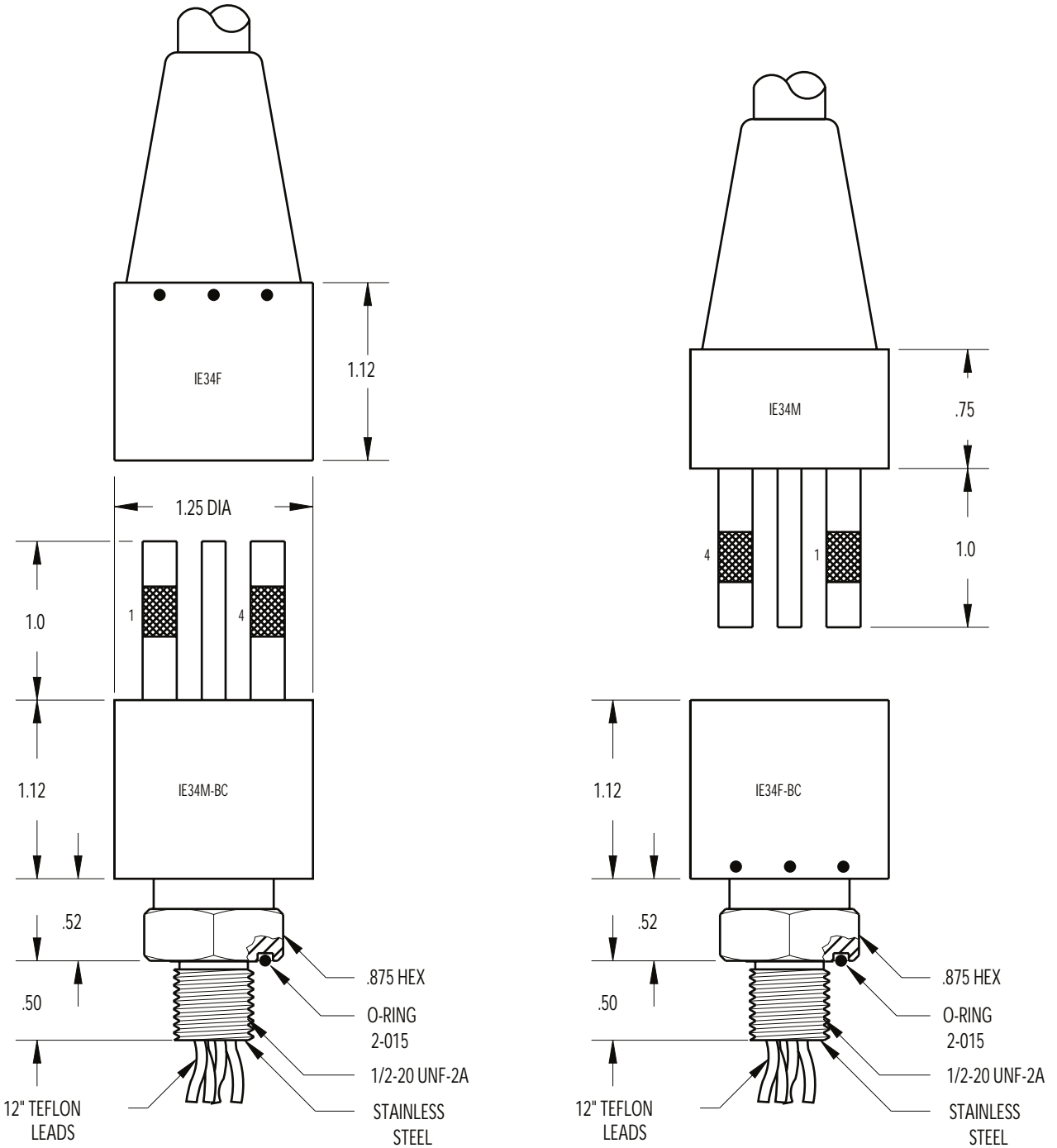

MOUNTING TORQUE FOR BC	not to exceed 100 in/lbs
MATED PRESSURE RATING (psi)	10,000
DUMMY PLUG FOR IE34M-BC, IE34M	IE34F-DO *
DUMMY PLUG FOR IE34F-BC, IE34F	IE34M-DO *
* Shorted dummies (DS) available upon request.	

CONTACT CONFIGURATIONS
(IE34M FACE VIEW)

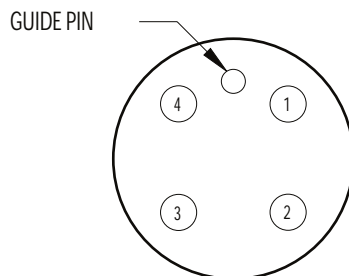

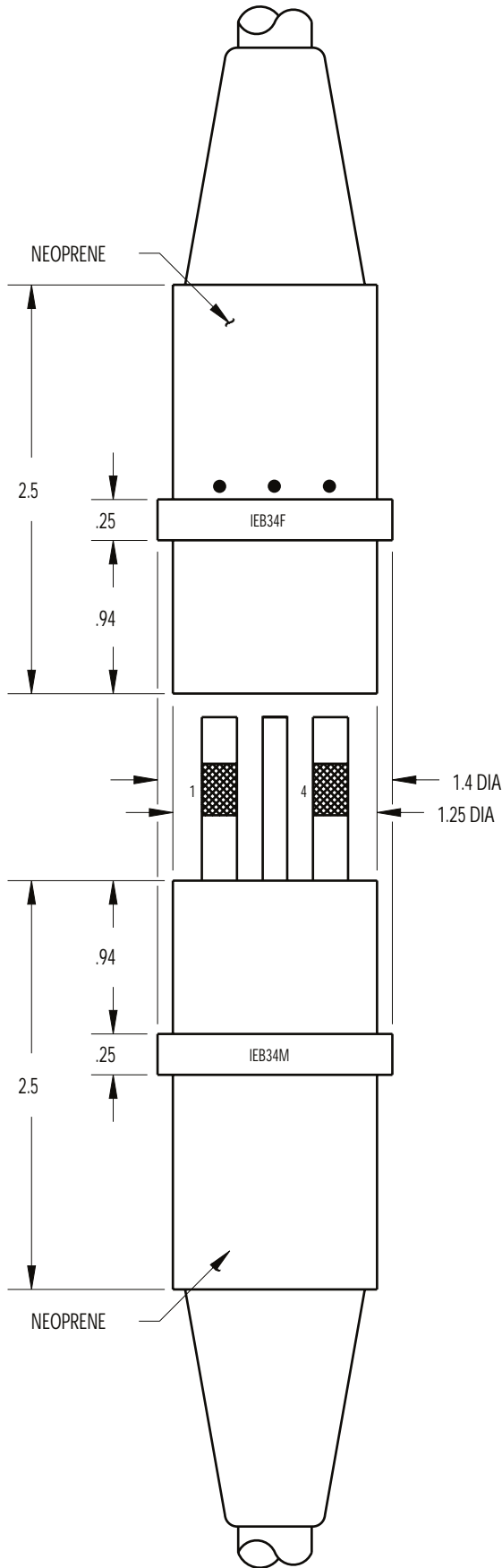

CONTACT
CONFIGURATIONS
(IEB34M FACE VIEW)

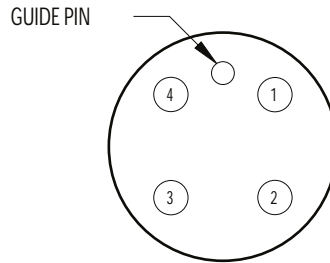

MATED PRESSURE RATING (psi)	20,000
DUMMY PLUG FOR IEB34M	IEB34F-DO *
DUMMY PLUG FOR IEB34F	IEB34M-DO *

* Shorted dummies (DS) available upon request.

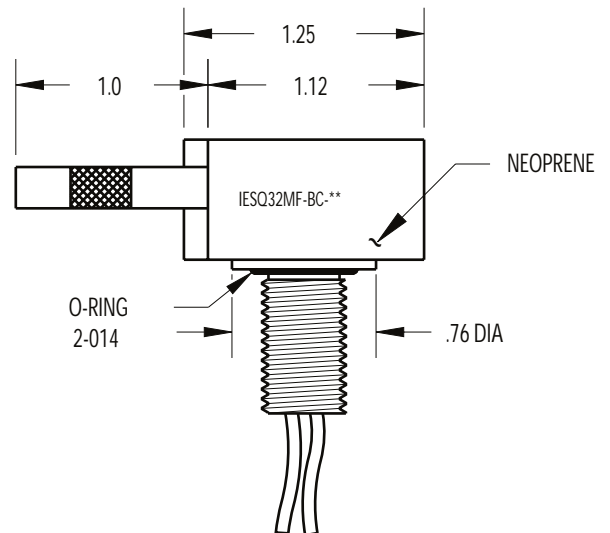
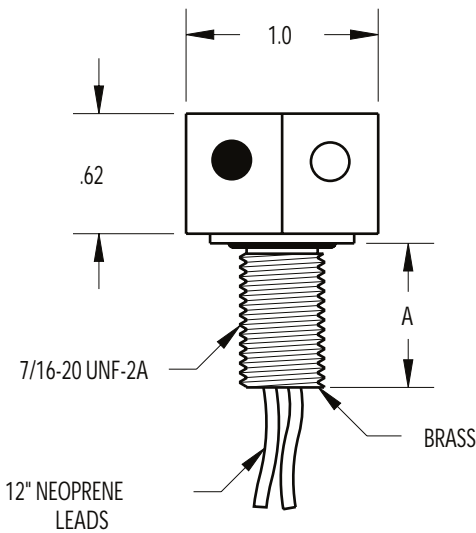
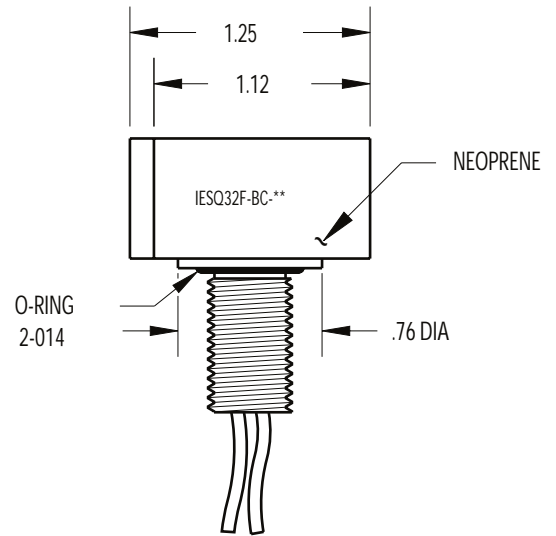
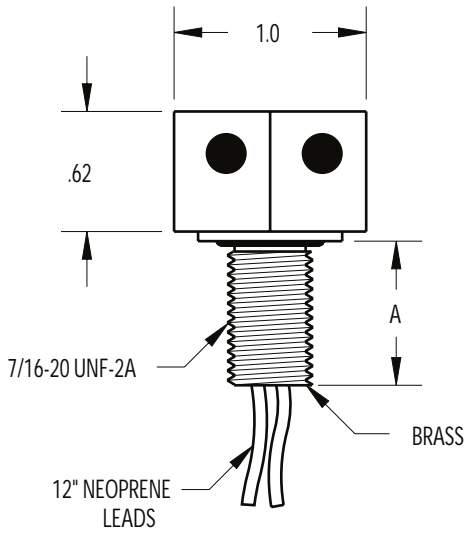
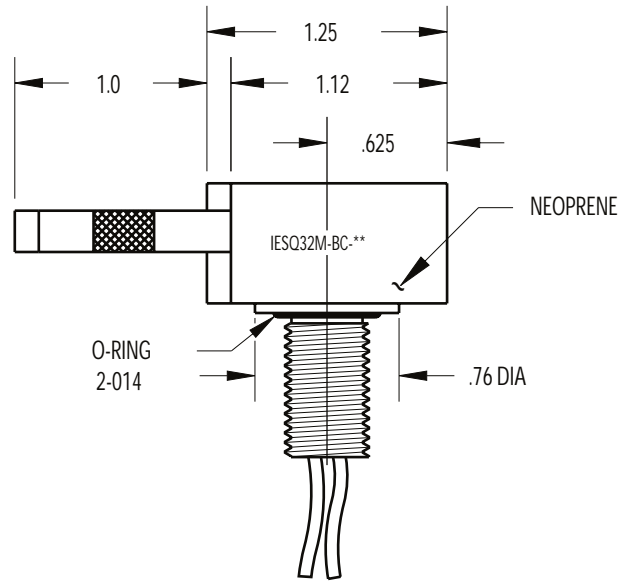
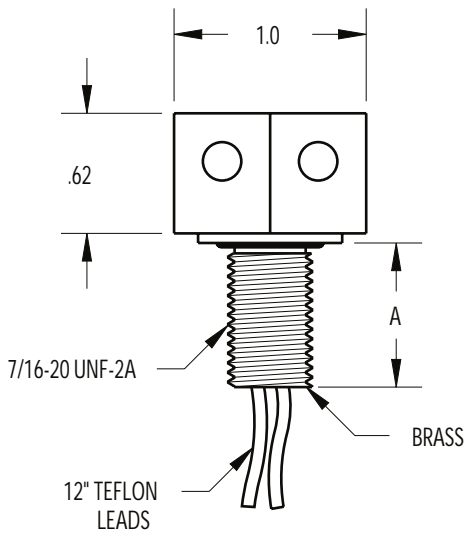

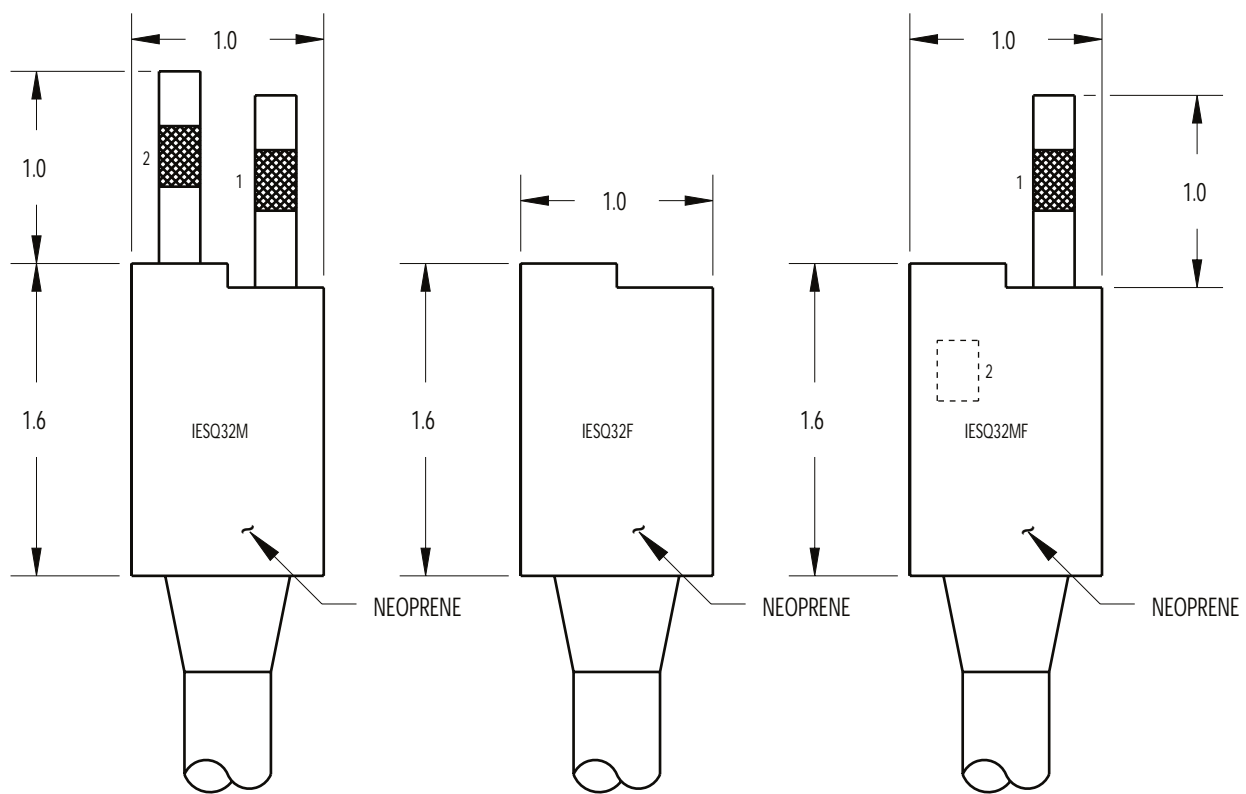

MOUNTING TORQUE FOR BC	not to exceed 100 in/lbs
MATED PRESSURE RATING (psi)	5,000
DUMMY PLUG FOR IESQ32M-BC, IESQ32M	IESQ32F-DO *
DUMMY PLUG FOR IESQ32F-BC, IE32F	IESQ32M-DO *
DUMMY PLUG FOR IESQ32MF-BC, IESQ32MF	IESQ32MF-DO *
* Shorted dummies available upon request. ** See chart for thread specifications. *** Specify M/F/MF	

BULKHEAD	
PART NUMBER	A
IESQ32***-BC-1	.50
IESQ32***-BC-2	.75
IESQ32***-BC-3	1.00