

BULKHEAD CONNECTOR RECEPTACLE

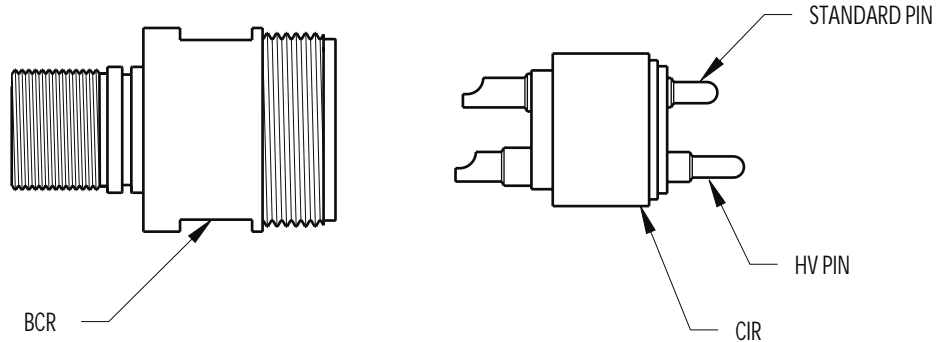

MSSL- * -BCR PBOF HV

DESCRIPTION:

SHELL TYPE: MS - METAL SHELL
 SHELL MATERIAL: S - STAINLESS STEEL
 SHELL SIZE: L
 CONTACT CONFIGURATION: *
 PART TYPE: BCR - BULKHEAD CONNECTOR RECEPTACLE
 SPECIAL FEATURES: PBOF - PRESSURE BALANCED OIL FILLED
 SPECIAL CONTACT SPECS: HV - HIGH VOLTAGE

CABLE CONNECTOR PLUG

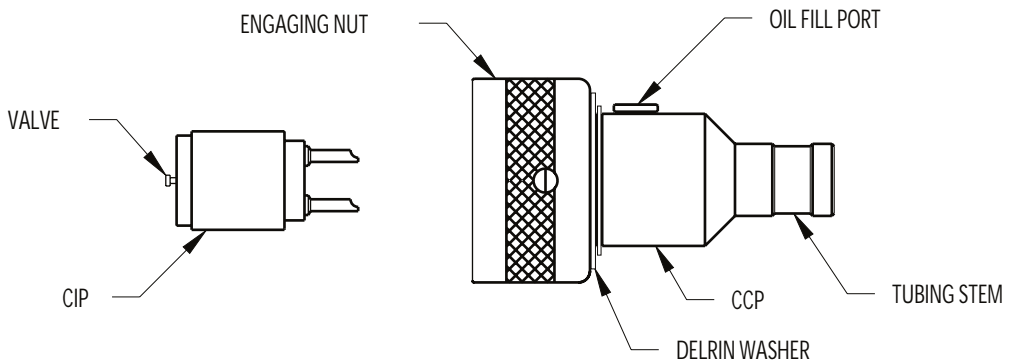

MSAL- * -CCP PBOF w/ 3/4" Tube

DESCRIPTION:

SHELL TYPE: MS - METAL SHELL
 SHELL MATERIAL: A - ALUMINUM
 SHELL SIZE: L
 CONTACT CONFIGURATION: *
 PART TYPE: CCP - CABLE CONNECTOR PLUG
 SPECIAL FEATURES: PBOF - PRESSURE BALANCED OIL FILLED
 3/4" TUBE - ID OF TUBING TO BE USED
 (3/4" STANDARD FOR OCEANEERING)

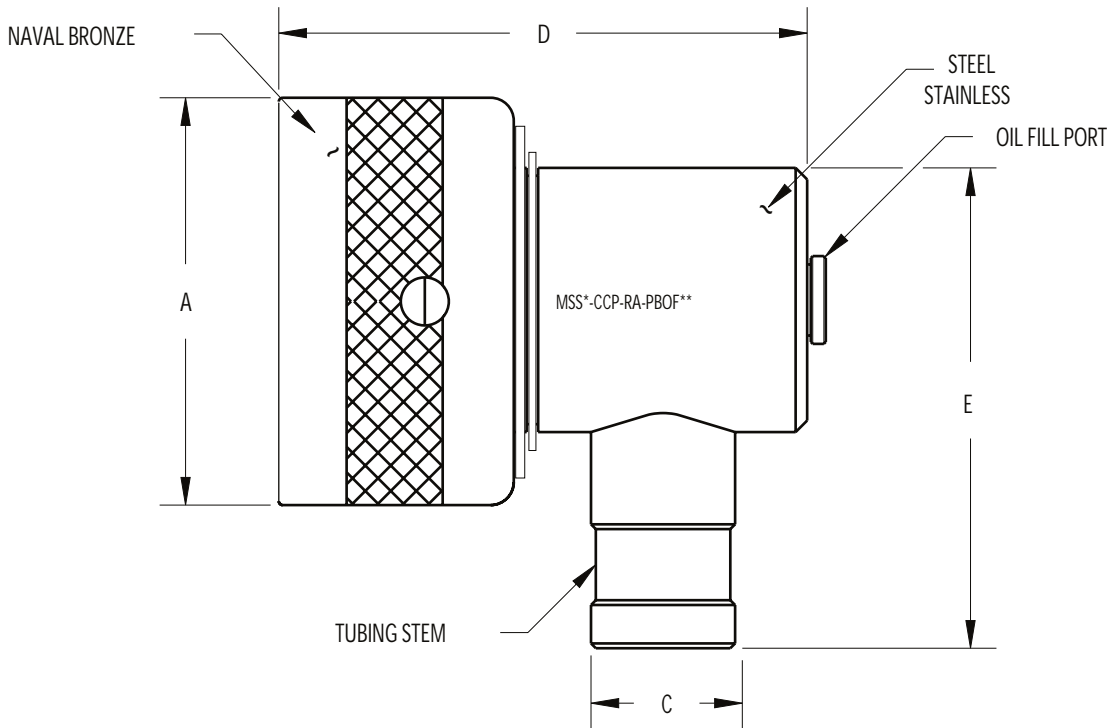
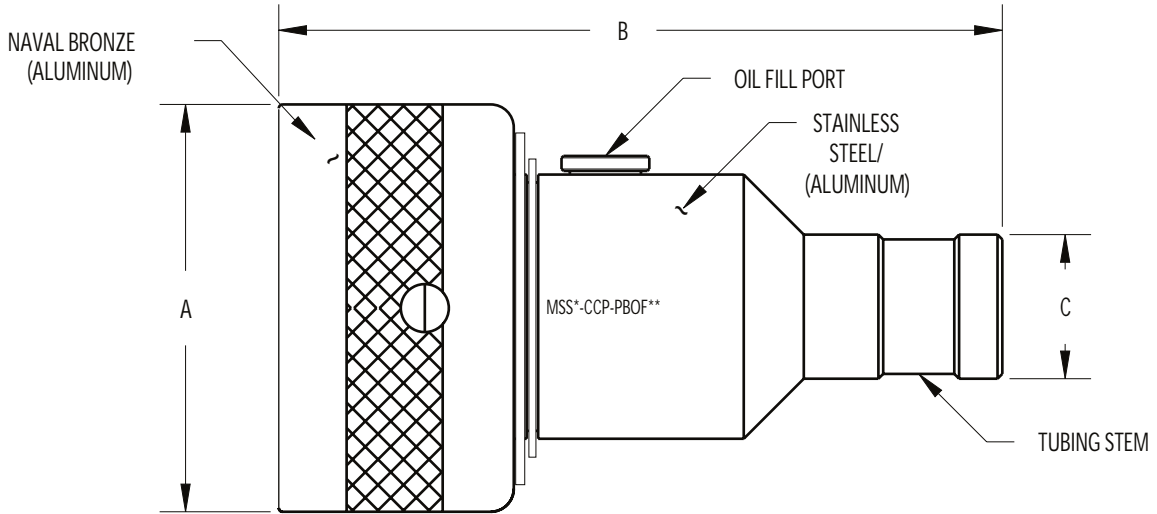

SHELL SIZE	A	B	C	D	E
K	1.87	3.50	1/2" MAX	2.60	2.12
L	2.12	3.75	3/4" MAX	2.75	2.50
M	2.75	5.00	1" MAX	3.70	3.00
Q	4.50	7.00	1-1/4" MAX	4.00	4.12

NOTE: Specify O.D. of tube at time of order.

* Specify shell size.

** See Technical Bulletin 45 72 for internal assembly and hardware specifications

K SIZE CONTACT
CONFIGURATION
(BCR FACE VIEWS)

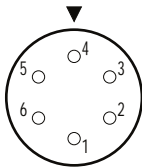

6#16

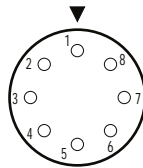

8#16

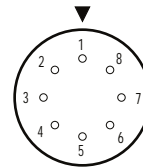

8#20

L SIZE CONTACT
CONFIGURATION
(BCR FACE VIEW)

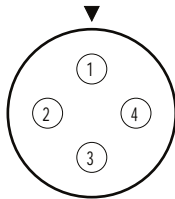

4#8
High Voltage

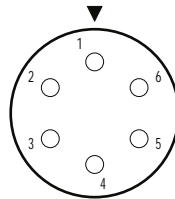

6#14

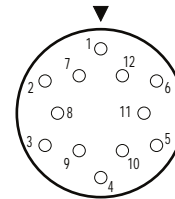

12#16

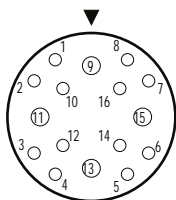

4#14
12#16

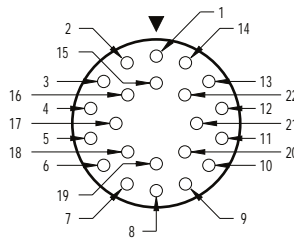

22#16

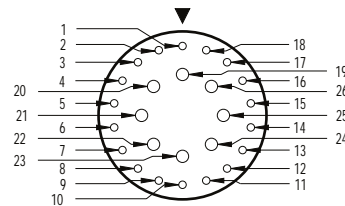

8#16
18#20

M SIZE CONTACT
CONFIGURATION
(BCR FACE VIEWS)

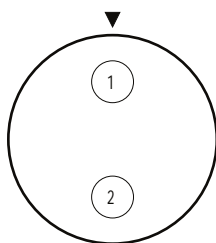

2#6

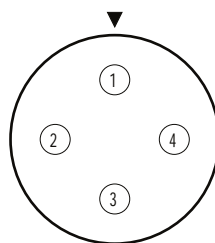

4#8*

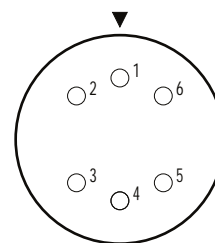

6#14

* Available in high voltage.

M SIZE CONTACT
CONFIGURATION

(BCR FACE VIEWS)

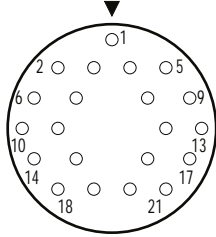

21#16

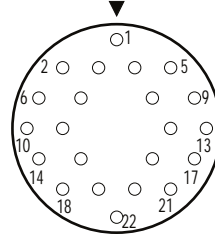

22#16

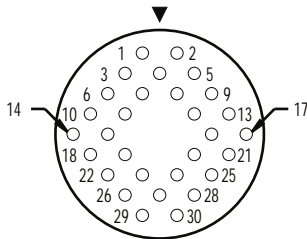

30#16

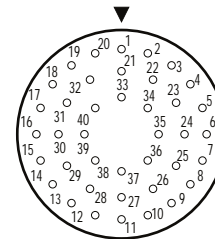

40#20

Q SIZE CONTACT
CONFIGURATION

(BCR FACE VIEWS)

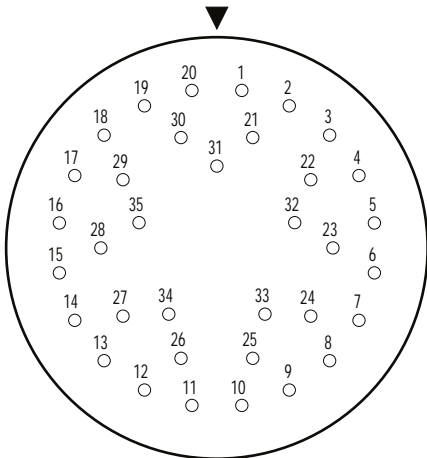

35#16
(High Voltage)

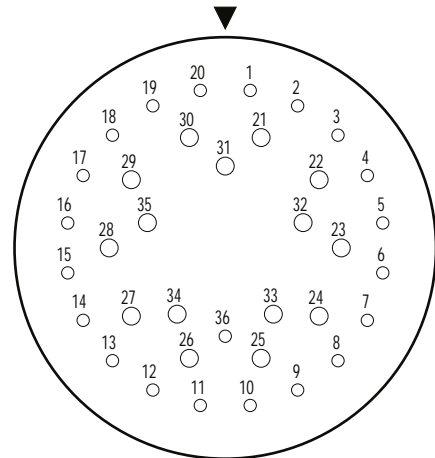

15#14
21#16
(High Voltage)